

International Conference on Space Optics—ICSO 2022

Dubrovnik, Croatia

3–7 October 2022

Edited by Kyriaki Minoglou, Nikos Karafolas, and Bruno Cugny,

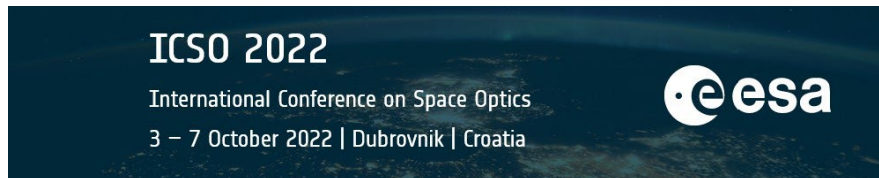

Iodine based reference laser for ground tests of LISA payload



Iodine based reference laser for ground tests of LISA payload

A. Mehlman^{*a-b}, D. Holleville^a, M. Lours^a, B. Pointard^a, R. Le Targat^a, P. Wolf^a, S. Bize^a,
O. Acef^a, A. Boutin^b, K. Lepage^b, L. Fulop^b, H. Halloin^c, T. Zerguerras^c,
J. Hrabina^d, A. Hola^d, L. Ouda^e, R. Arguel^e

* alexis.mehlman@ixblue.com

^a LNE-SYRTE, Observatoire de Paris – 61 Ave. de l'Observatoire, Paris 75014, France

^b iXblue – Photonic Solutions Division, 10 Rue de Montmorency, Paris 75003, France

^c APC, Université Paris 7, 10 rue Alice Domon et Léonie Duquet, Paris 75013, France

^d Institute of Scientific Instruments, Kralovopolska 147, BRNO, 612 64, Czech Republic

^e CNES, Centre National d'Etudes Spatiales, 18 avenue Edouard Belin, 31401,
Toulouse Cedex 9, France.

ABSTRACT

We report on the development of a transportable iodine frequency stabilized laser setup, based on compact-fibered frequency tripled Telecom laser, locked to the a_{10} hyperfine component of the $^{127}\text{I}_2$ line at 532.245 nm. Therefore, a tandem of Nd: YAG lasers are phase-locked to this reference laser and used for precise interferometry measurements as part of the French activities in the frame of LISA-France consortium, led by the French space agency (CNES). The frequency stability transfer from 1596 nm to the LISA nominal wavelength at 1064.49 nm is fulfilled in a simple manner [1], using the usual phase locking loop technique associated to a second harmonic generation process. The compact design of the whole setup will make it easily transportable and can be readily used on different sites.

Keywords: ultra-stable laser, transportable frequency reference, iodine reference, LISA, Telecom laser, Doppler-free spectroscopy, nonlinear crystals, PPLN.

1. INTRODUCTION

Ultra-stable and transportable lasers provided in compact optical architecture are an important technological key for many applications, such as gravitational wave detection in earth/space, earth observations, ground to space or inter-satellites optical links, fundamental physics, accurate laser ranging [2-4], etc.. The iodine molecular lines located in the green range of the optical domain, offer an interesting possibility for the development of transportable atomic clock, with high performance and compact instrumental configurations. Furthermore, the existence of high efficiency nonlinear crystals, such as periodically-poled Lithium Niobate crystals (PPLN), makes it easy to bridge the frequency gaps between the green range and the infrared (IR) domain where various low phase noise and powerful lasers are available, like Nd: YAG lasers (@ $\sim 1 \mu\text{m}$) and Er based lasers in the Telecom bands ($\sim 1.5 \mu\text{m}$) [3, 5].

The LISA space mission aims to detect gravitational waves using optical cavity-frequency stabilized 1064 nm lasers, with a residual frequency noise requirement at the level of $30 \text{ Hz}/\sqrt{\text{Hz}}$ or $\sim 10^{-13} \tau^{-1/2}$ in terms of Allan standard deviation. The AIVT activities associated to the LISA mission require a compact and transportable frequency reference with a frequency residual noise below those specifications, as those activities will be carried out in different laboratories. The SYRTE laboratory will provide a laser setup meeting the mission requirements, based on a tandem of Nd: YAG lasers operating around 1064.49 nm, linked to an ultra-stable iodine frequency reference. The SYRTE approach uses a frequency-tripled Erbium doped fiber laser at 1596.73 nm, stabilized to the a_{10} hyperfine component of the R56 [32-0] $^{127}\text{I}_2$ line at 532.245 nm. Residual frequency noise below the LISA mission specification has been already demonstrated using this method with other wavelengths located in the C-band of telecom domain (1542 nm and 1544 nm) linked to iodine lines at 514 nm and 515 nm respectively [6, 7].

Indeed, Telecom components offer a high TRL and allow for a fully fibered setup, which comprises two parts: firstly, the third harmonic generation (THG) process, the phase-frequency modulation, and the stabilization devices, and secondly a monolithic fiber coupled optical bench, using a compact iodine cell to perform the Doppler-free spectroscopy. The whole setup is depicted on Figure 1.

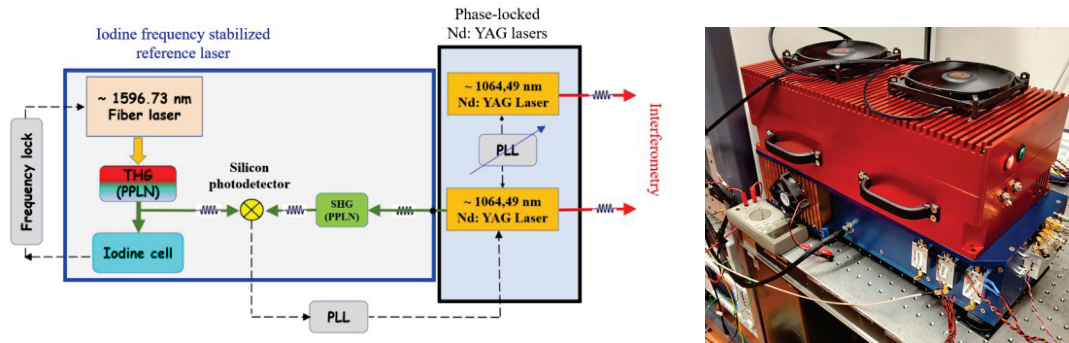

Figure 1- left: Schematic diagram of the laser system designed for LISA mission ground tests
Figure 1- right: Photography of the iodine frequency stabilized Telecom laser

2. EXPERIMENTAL SETUP

2.1.1 Third harmonic generation process (THG)

The third harmonic generation (THG) process is fulfilled using two cascaded PPLN crystals (Figure 2a). The laser source is an erbium doped fiber laser with an output power of 10 mW and a linewidth <1 kHz. Two Erbium doped fiber amplifiers (EDFA), generating respectively 1 W and 500 mW, are used to reach the power-levels required for the non-linear processes. We operate a frequency doubling process (SHG: $\omega + \omega \rightarrow 2\omega$), followed by a sum generation (SFG: $\omega + 2\omega \rightarrow 3\omega$). This process has previously been demonstrated to generate enough power for the iodine Doppler-free spectroscopy [6, 7]. Both crystals are temperature phase-matched within 1 mK residual temperature fluctuations. The temperatures phase matching are 41°C for SHG and 47°C for SFG. The output power at 532 nm is around 30 mW, coupled through a polarization maintaining fiber to the iodine spectroscopic bench (Fig. 2b). A small part of that optical power at 532 nm (~ 0.5 mW) is used for the phase locking of the Nd: YAG lasers against the iodine frequency reference (Fig. 1 left). All the fibers used in the setup are polarization-maintaining fibers. The total volume occupied by this setup 15 liters ($500 \times 220 \times 150 \text{ mm}^3$) (Fig. 2b).

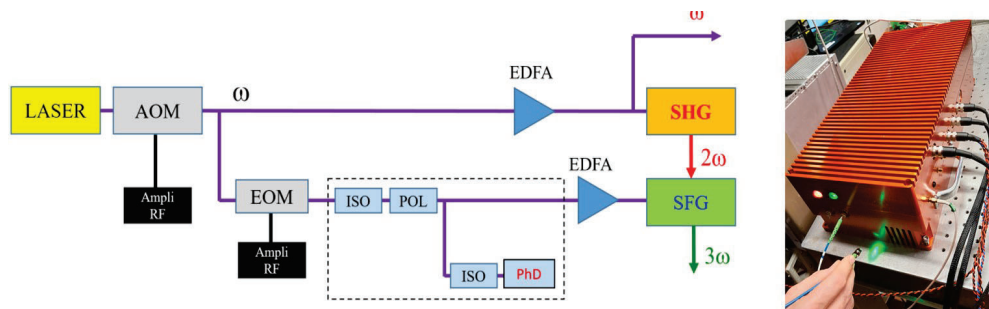

Figure 2a: scheme of the laser source.

Figure 2b: Photography of the laser source

2.1.2 Sum Frequency Generation process

The frequency doubling process is achieved using fully fibered PPLN crystal provided by NEL Co (Japan). However, we have not been able to acquire the SFG crystal, coupled by optical PM fibers at the three wavelengths (ω , 2ω , 3ω) involved in this process.

As the SFG device was the only component of the THG source that is not commercially available, it was specifically developed by iXblue to be fully fibered, compact, and transportable. The scheme is detailed in Figure 3. The PPLN crystal is a 40 mm long bulk ($500 \times 500 \mu\text{m}^2$), provided by Covesion® (UK). Using iXblue photonic solutions division's know-how (previously Kyliia), a precise control of the infrared and red waists and superimposition of the two beams allowed for a conversion efficiency ($\Gamma = P_{3\omega} / (P_{\omega} * P_{2\omega} * L)$) of 5 %/(W.cm) (Fig. 4).

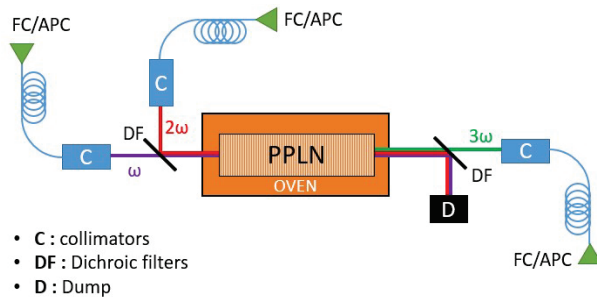

Figure 3a: Scheme of the SFG optical configuration.

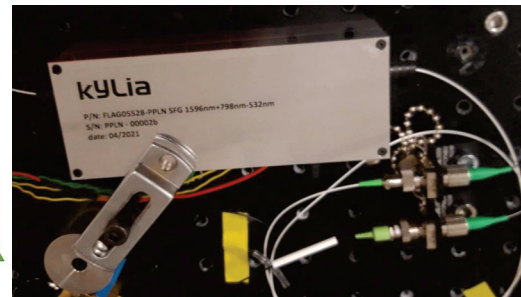

Figure 3b: Photography of the assembled device.

The ratio of the confocal parameter (twice the Rayleigh length) to the length of the crystal is chosen as 2.84, to achieve optimal conversion efficiency. Consequently, this implies a waist of $60 \mu\text{m}$ for the IR beam, and of $40 \mu\text{m}$ for the red beam. The collimator for the green output fiber was built using the in-situ out coming signal, but the focal of the lens was chosen on the hypothesis that the confocal parameter of the beam would be the same as the IR and red beams. With an 80 % coupling efficiency in the output fiber, this allowed the output power to be above 30 mW at 532 nm, with about 1 W of infrared and 220 mW of red. Taking into account the 0.5 W of IR power used in the SHG process, we obtain an optical efficiency ($\eta = P_{3\omega} / P_{\omega}$) of 2%.

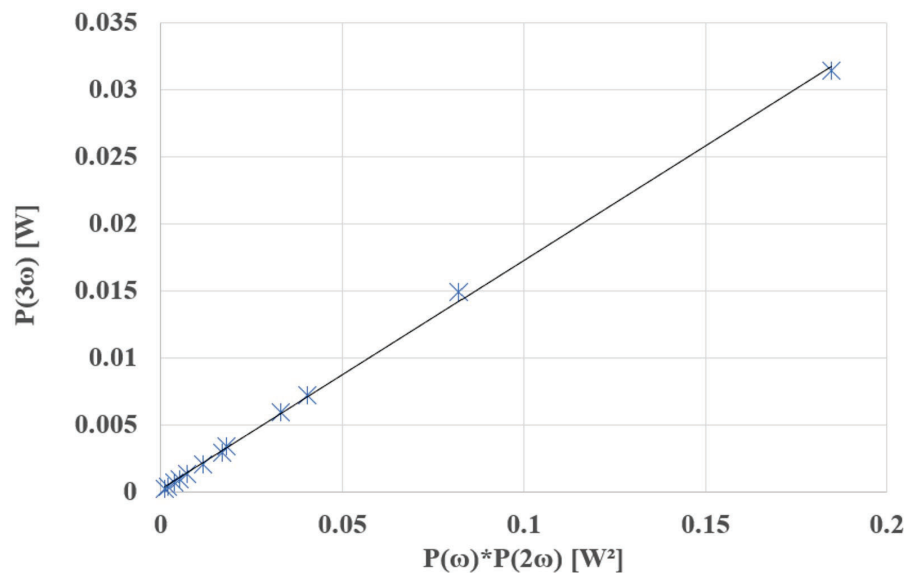

Figure 4. Conversion efficiency of the 40 mm long SFG crystal

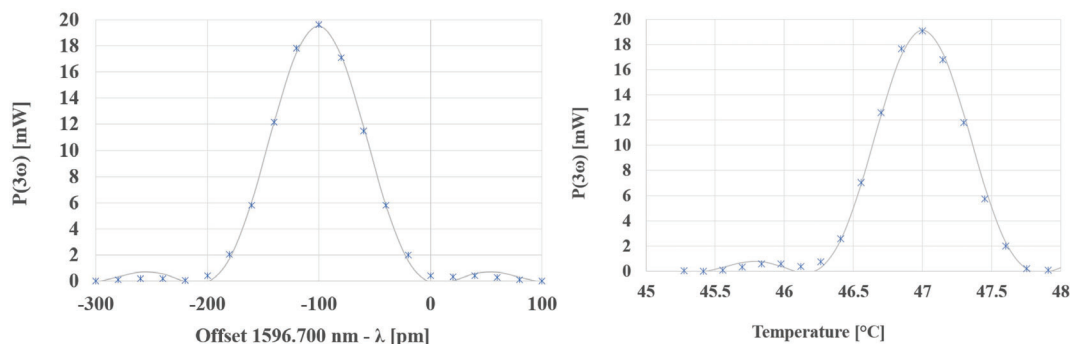

Figure 5. Left: Wavelength acceptance of SFG device.

Right: Temperature acceptance.

The wavelength and temperature acceptances full width at half maximum (FWHM) have been carefully measured as 100 pm and 0.8 °C respectively (Fig. 5).

2.1 Doppler-free spectroscopy setup

The iodine-based frequency reference laser setup uses a low phase noise frequency tripled Telecom fiber laser (linewidth <1 kHz) operating at 1596.7 nm, coupled to a monolithic and very compact iodine Doppler free spectroscopy optical bench. We use a compact iodine cell (15 x 8 x 4 cm³) developed in the frame of a scientific collaboration with the ISI lab in BRNO (CZ).

The iodine Doppler-free spectroscopy was made using iXblue photonic solutions division’s expertise. The full setup is described in Figure 6. It includes in-cell dichroic mirrors to reduce losses at interfaces and to reach smaller volumes. The iodine pressure is set using a cold finger cooled down to -15 °C within less than 0.1 mK, leaving a pressure inside the cell of around 1 Pa. The pump and probe powers are respectively 3 mW and 300 μW. With 8 passes inside the cell, the length of interaction with the molecular vapor is 1.2 m. The setup is fully monolithic (fused silica) using bonding between the components. The technique used allows very good long-time stability and mechanical stress resistance. The photodiodes electronics were specifically made for this development by the electronic lab at the SYRTE. We have used calcites crystals to make the superimposition and separation of the probe and pump beams (orthogonal polarizations). The hyperfine transition used in this work is the a₁₀ hyperfine component of the R 56 [32-0] line at 532.245 nm.

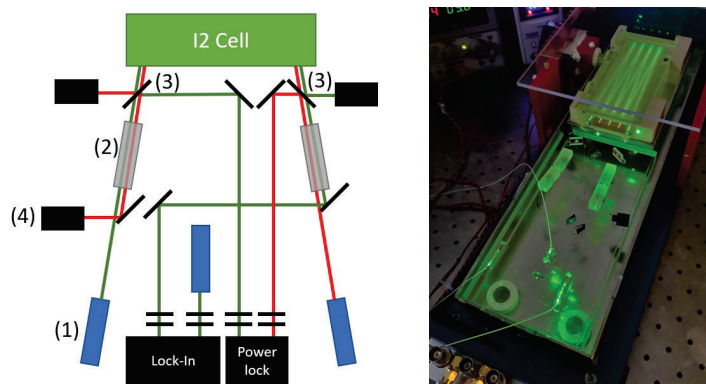

Figure 6 Left: scheme of the spectroscopy setup. (1) Fibered collimators, (2) Calcite crystals. (3) Beam samplers for power-locks. (4) Light traps.

Figure 6 Right: Picture of the spectroscopy optical bench.

3. EXPERIMENTAL RESULTS

3.1.1 Optical Powers stabilities

The power induced frequency shift is reported roughly below a few kHz per mW/mm² [8]. To achieve a 10⁻¹⁴ residual frequency instability, it is necessary to have an optical residual intensity noise of the probe and the pump below the 10⁻⁴ levels. To do so, AOMs are used to control the intensity levels of the probe and the pump beams. The beam samplers used for the power-locks are wedged silica plates with an uncoated surface for the sampling, and an anti-reflective coating on the exiting surface to reduce ghosting. This allows to reduce long-term fluctuations as the sampling only relies on the Fresnel coefficients and incident angles which are insignificantly changing over time. The use of home made power-locks at SYRTE allows to be well below the required residual noise, as shown in Figure 7.

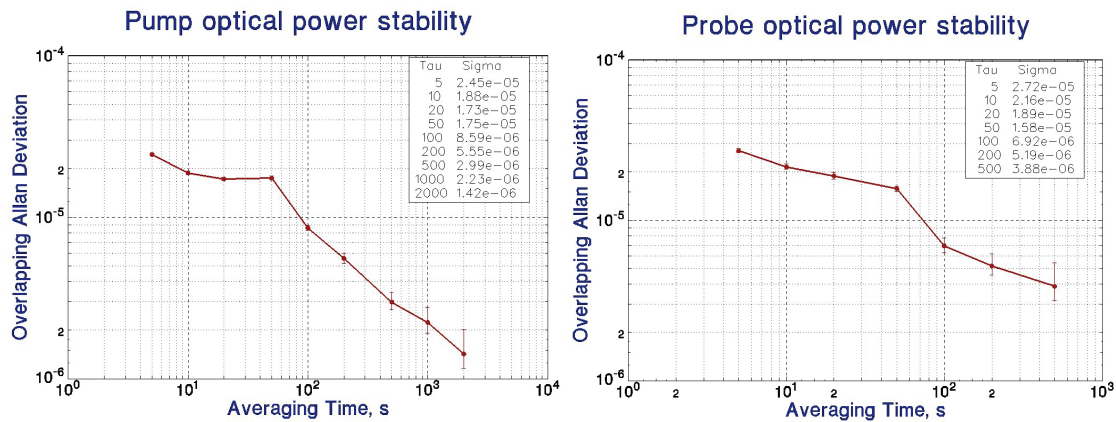

Figure 7. Left: Overlapping Allan Deviation of the pump power at 3 mW. Right : Overlapping Allan Deviation of the probe power at 300 μW (out of loop measurements).

3.1.2 Iodine pressure stability

The pressure induced shift is of a few kHz/Pa [8]. The pressure stability is achieved via the temperature stabilization of the cold finger of the quartz sealed cell. This temperature is chosen with regards to the signal to noise ratio and the slope of the signal. It usually lies in the -15/-17 °C range. In this range the experimental iodine linewidth is estimated as ~ 0.5 / 0.7 MHz. The fractional residual temperature fluctuations are measured to be below 10⁻⁴ (Figure 8).

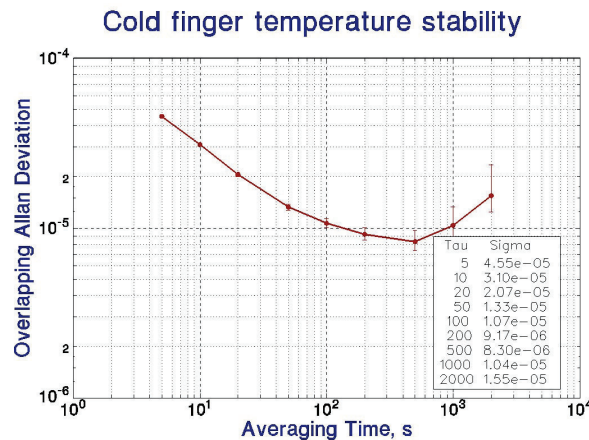

Figure 8. Overlapping Allan Deviation relative to the residual temperature fluctuations of the cold finger (out of loop measurements).

3.1.3 Zeeman Effect

Hyperfine iodine lines are sensitive to environmental magnetic fields. The dependency has been measured previously as $\sim 1 \text{ Hz} / \text{mG}$ [7]. In order to avoid this effect, we used two magnetic shields in the spectroscopy bench. One surrounds the iodine cell, the other encloses the whole optical bench (Fig. 9).

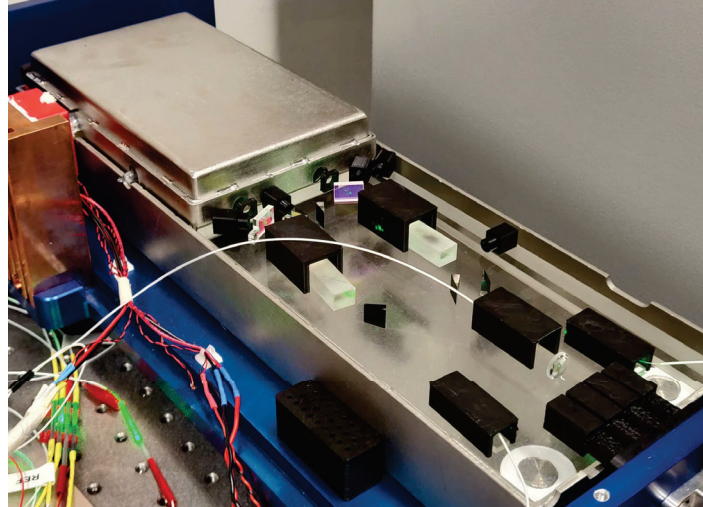

Figure 9 : Picture of the monolithic optical bench. The top of the external magnetic shielding is not in place.

We have measured the residual magnetic field fluctuations inside the combined magnetic shields as depicted on figure 10. For the ground tests of the LISA payload, using our iodine frequency reference, only the magnetic field fluctuations limit the frequency stability. We have measured that the attenuation factor of our magnetic shields assembly is at the level of 1000. Therefore, our setup should not be used in an environment where magnetic field fluctuations are above 1 G, if we want to reach frequency instability limit at the level of 10^{-15} .

In the Paris Observatory environment, the railway (train + subway) public transportation system generates magnetic fluctuations of a few mG as shown in Figure 10. Using the two magnetic shields we could not measure any fluctuation above 0.1 mG, limited by our setup measurement.

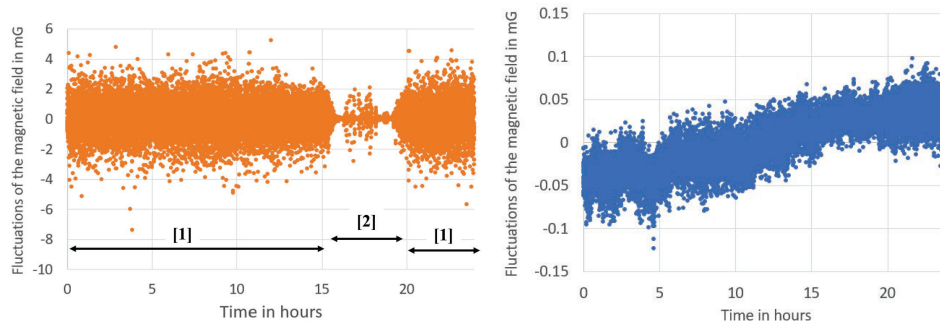

Figure 10. Left: magnetic field fluctuations on the vertical axis at the SYRTE laboratory. [1] = Railway operating hours, [2] = Night time with summer railway maintenance works. Right: magnetic field fluctuations on the vertical axis at the center of the cell's location into the two magnetic shields. The two measurements have been taken in parallel.

3.1.4 Hyperfine molecular signals

The frequency modulation used for the saturated absorption signals is applied of the IR EOM shown on figure 2. The fibered EOMs in the visible part of the spectrum, especially in the green range exhibit much higher insertion losses than the ones in the Telecom bands. At the beginning of this development, we were expecting an optical power generation at 532 nm below 15 mW. For this reason, an infrared EOM was chosen with frequency modulation of 200 kHz. This use implies a frequency modulation of both the pump and the probe beams. Thus, the hyperfine components are affected by the background linear absorption. Nevertheless, previous work at SYRTE has shown that the stability requirements of the LISA mission can be achieved using this kind of frequency modulation [7]. We have chosen to detect both first and third derivative of the iodine saturated signal using dedicated locking amplifier developed at SYRTE. The performances of our setup using either one or the other or both of the derivatives are under evaluation. Figure 11 illustrates the successive odd derivatives of iodine saturated signal.

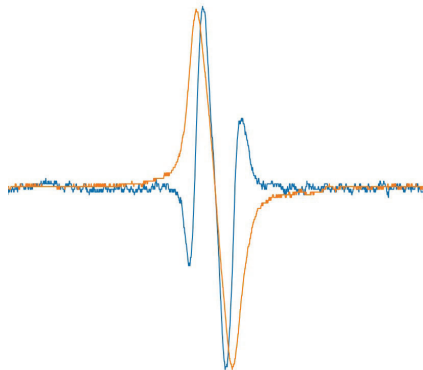

Figure 11. Comparison of the first and third derivatives measured in parallel. Vertical and horizontal units are arbitrary. The signals were obtained using the monitoring output of the lock-in amplifier, which includes a 1ms filter. The pump power was 3 mW, the probe power was 300 μ W, with a modulation frequency of 200 kHz.

4. CONCLUSION

We demonstrate the possibility of making a compact (30L) and transportable frequency stabilized laser on iodine line at 532 nm. The signals obtained until now are very promising, even though frequency stability measurements remain to be made. This setup can be replicated over all the telecommunication bands (C+L) as the components are the same, allowing further and different applications. All the components used are space qualified, except for the SFG and the spectroscopy bench, which use assembly techniques already proven to meet space qualifications, and the iodine cell. The frequency stability of our laser system will be presented at the conference.

REFERENCES

- [1] N. Chiodo, F. Du-Burck, J. Hrabina, M. Lours, E. Chea, and O. Acef, "Optical phase locking of two infrared continuous wave lasers separated by 100 THz", *OPTICS LETTERS* / Vol. 39, No. 10 / May 15, 2014
- [2] P.L. Bender, J.L. Hall, J. Ye, W.M. Klipstein, "Satellite-satellite laser links for future gravity missions", *Space Science Reviews* **108**: 377–384, 2003
- [3] T. Schuldt et al., "An ultra-stable frequency reference for space", ICSO 2014, International Conference on Space, Optics, Tenerife, Canary Islands, Spain, 7–10 October (2014)
- [4] T. Leveque, C. Fallet, M. Manda, R. Biancale, J. M. Lemoine, S. Tardivel, S. Delavault, A. Piquereau, Bourgogne, F. Pereira Dos Santos, R. Battelier, Ph. Bouyer, "Gravity Field Mapping Using Laser Coupled Quantum Accelerometers in Space, [arXiv.org > physics > arXiv:2011.03382v1](https://arxiv.org/abs/2011.03382v1).
- [5] C. Philippe et al., "Efficient third harmonic generation of a CW-fibered 1.5 μ m laser diode, *Appl. Phys. B* (2016) 122, p. 265.

- [6] C. Philippe et al., “Frequency tripled 1.5 μm telecom laser diode, stabilized to iodine hyperfine line in the 10-15 range” 30th European Frequency and Time Forum, EFTF 2016, 4th–7th April 2016, York, United Kingdom. And references therein.
- [7] J. Barbarat et al. “Linear Zeeman Effect on Iodine-Based Frequency Stabilized Laser”, Proceedings of IFCS-EFTF’2019. Orlando, Florida (USA).
- [8] S. Picard et al. , “Comparison of 127I2-stabilized frequency-doubled Nd:YAG lasers at the Bureau International des Poids et Mesures”, Applied Optics, Vol. 42, N°6, 2003.